

LAYHER LIGHTWEIGHT MORE THAN JUST WEIGHT



Layher® 

More Possibilities. The Scaffolding System.

Layher®

Layher AllroundGerüst®
Layher Allround® Scaffolding



Layher GmbH & Co KG
www.layher.com | Made in Germany

From practical experience we know that assembly, dismantling and transport make up some 80% of scaffolding construction costs. A reduction in the component weight enables our customers both to increase their assembly and dismantling capacities considerably, and to make better use of transport capacities. This is where our Layher Lightweight philosophy comes into play. By using higher-strength steel grades, new production processes and design improvements, we have succeeded in minimising the weight of the basic components of our SpeedyScaf and Allround Scaffolding systems – with the same or even higher load-bearing capacities. **The assembly capacity can be increased by up to 10%, and the transport costs reduced by up to 12%***. As part of our integrated system, the Lightweight products can also be combined with our previous product versions. Combination approvals, instructions for assembly and use and load capacity tables are of course available.

THE SUCCESS
OF OUR CUSTOMERS
IS OUR OVERRIDING
PRIORITY.



LAYHER LIGHTWEIGHT

Transport, assembly and dismantling costs make up the biggest proportion of total costs. This is where the benefits of Allround Scaffolding Lightweight lie.

To make scaffolding even more economical and even safer, Layher development engineers are constantly working on ingenious new developments and improvements. Our focus here is on the factors influencing assembly performance, such as weight, shape and the number of components. To achieve this, we constantly search for new materials and new production processes. Just a few additional components also continuously open up new fields of business for our customers, since full utilisation of their material stocks is also a crucial factor in profitability. Thanks to uniform system dimensions and appropriate combination approvals, all our innovations are designed to be combinable with existing components of the Layher product portfolio – including our earlier product generations. This ensures protection of the investment: the strengths of our integrated system.

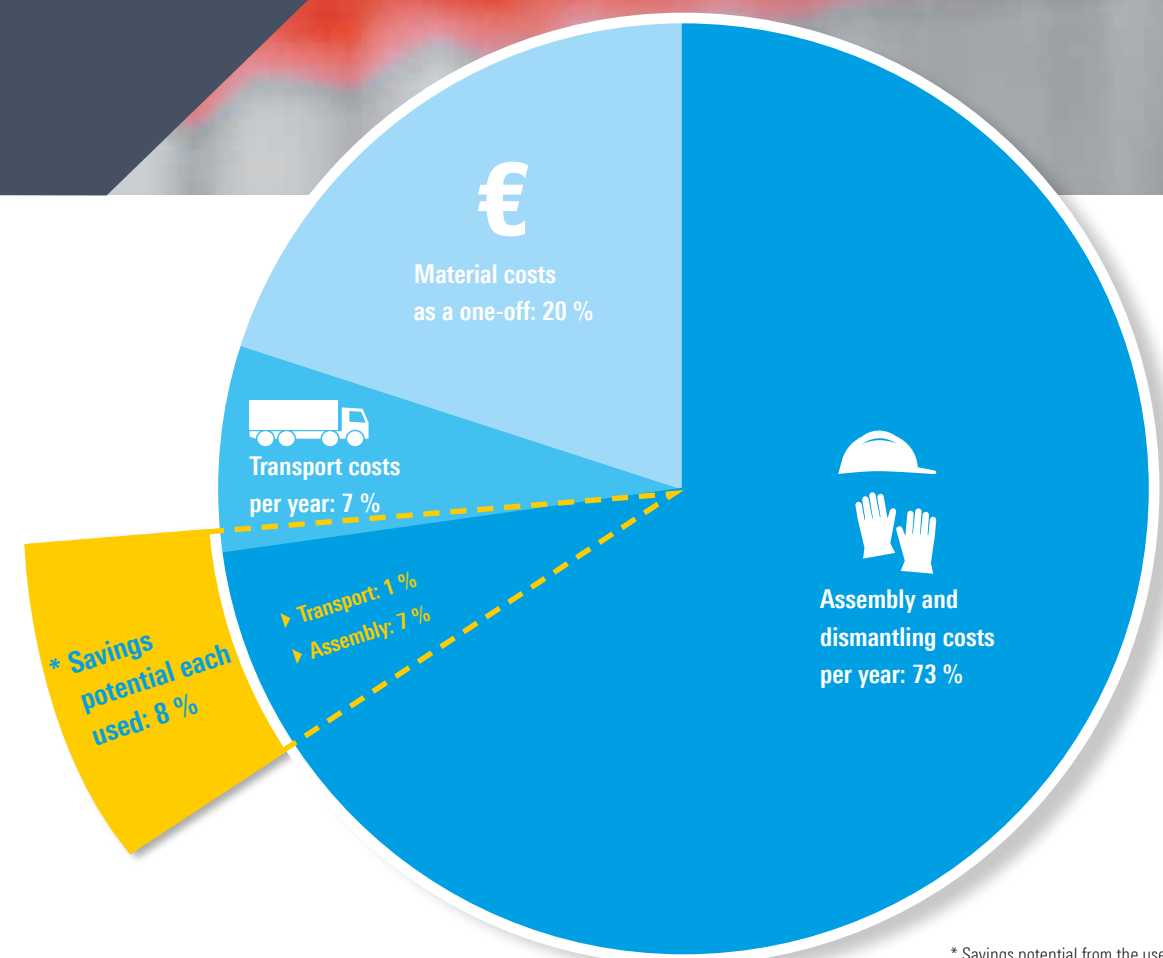

* Savings potential from the use of Allround Scaffolding Lightweight, assuming it is used five times a year.

LAYHER LIGHTWEIGHT

MORE THAN JUST WEIGHT

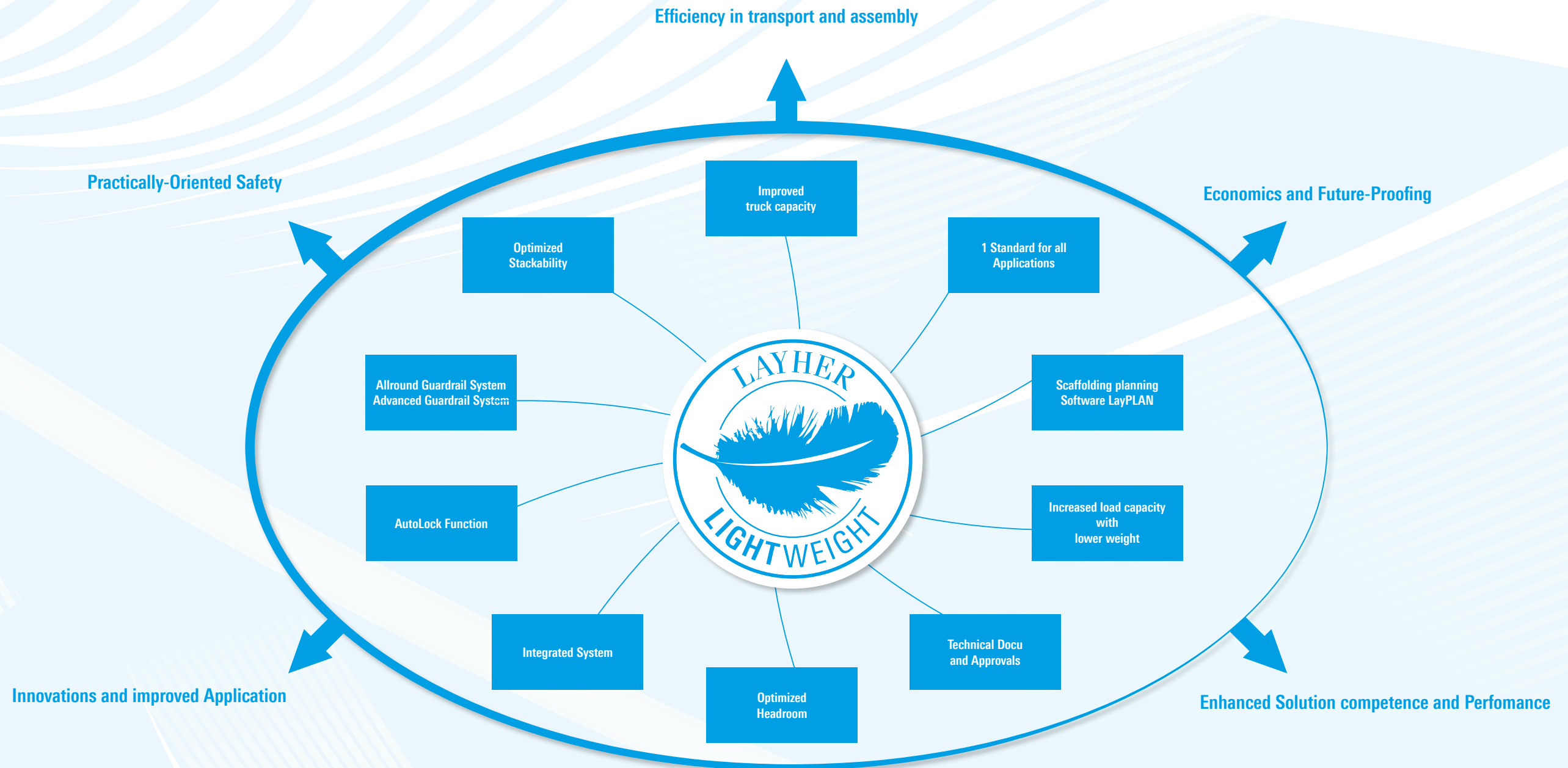

AUTOLOCK FUNCTION

The wedge head design with AutoLock function ensures even greater safety. A slight turn of the ledger activates its function, and after being slid onto the rosette the wedge drops automatically into the hole in the rosette, securing the ledger.

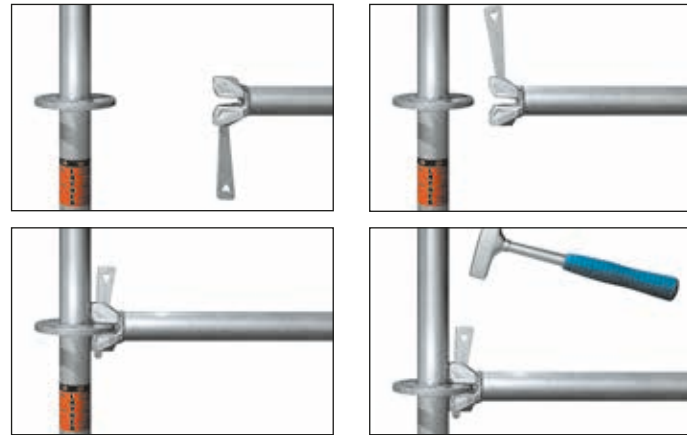

ADVANCE GUARDRAIL

The Layher AGR is used to prevent potential risks from falls during ascent to the topmost – and still unsecured – scaffolding level. For the longitudinal side of the scaffolding it consists of two aluminium guardrail posts and an aluminium telescoping guardrail. It is assembled from the secured level directly underneath. No assembly or dismantling sequence has to be followed. The single-piece End AGR is available especially for use over the full scaffolding length or when the access bay is placed at the end of the scaffolding. It is quickly clamped, using a spring mechanism, between the guardrail of the secured level and the deck ledger of the unsecured level.



ALLROUND GUARDRAIL SYSTEM

Using the AGS standard, facade scaffolding can be built with integrated advancing side protection, without the use of temporary protective components. During assembly, no assembly direction for the scaffolding bays has to be followed. The guardrails are already assembled from the level underneath and swung upwards together with the standard.



IMPROVED USE OF TRUCK CAPACITY

The reduction in the component weight means that transport capacity is increased. Transport costs can thus be reduced by up to 12 %.

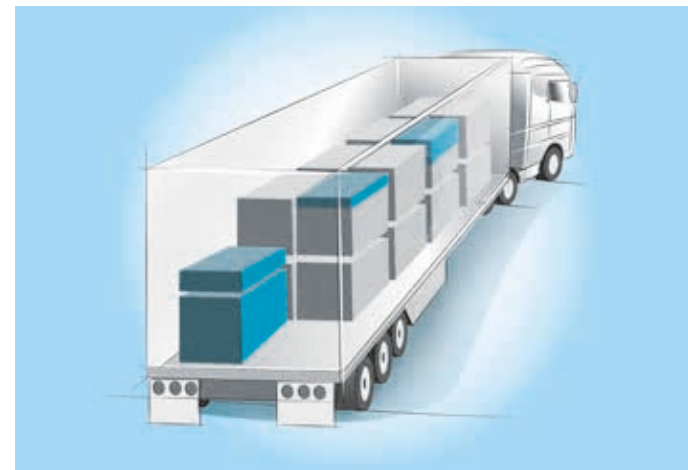

OPTIMISED HEADROOM

The use of higher-strength steel meant that a completely new type of U-ledger could be developed to replace the U-bridging ledger. The Allround U-Ledger LW reinforced has a reinforcing section on the underside which increases the clear headroom by about 10 cm. This takes the strain off the user and increases the assembly capacity.

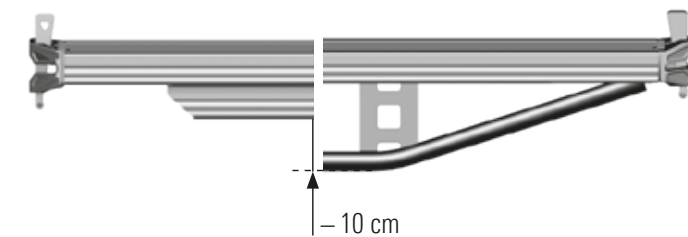

OPTIMISED STACKABILITY

The narrow reinforcing section permits nested stacking of the ledgers and so leads to a considerably reduced transport volume.

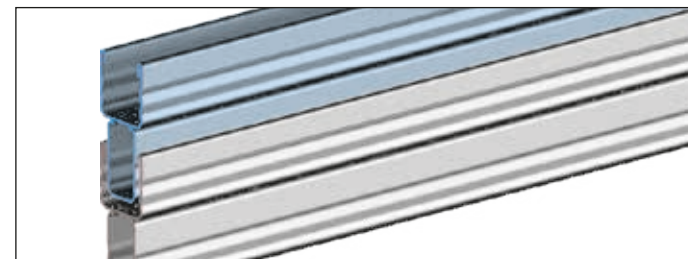

LOWER COMPONENT WEIGHT

The Steel Deck LW provides the same load-bearing capacities as the proven steel deck T4 – with a 10 % lower weight – thanks to the use of higher-strength steel and an intelligent combination of profiles and material concentrations at structurally relevant areas.

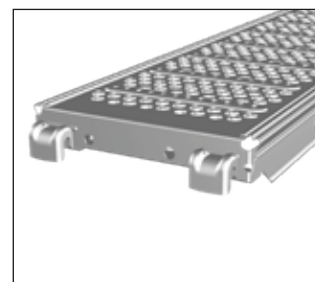

TECHNICAL DOCUMENTATION

Quick and easy access to information in instructions for assembly and use, approvals, technical brochures and type-tests.



SCAFFOLDING PLANNING SOFTWARE LAYPLAN

LAYPLAN CLASSIC

The LayPLAN CLASSIC modules for Allround Scaffolding and SpeedyScaf can be used for quick and easy configuration of individualised scaffolding solutions: whether they're for circular or facade scaffolding made from SpeedyScaf, for bird-cage scaffolding and free-standing towers made from Allround Scaffolding, or for structures with temporary roofs. Once the dimensions and the required assembly variant have been entered, LayPLAN CLASSIC delivers in seconds a scaffolding proposal including anchoring, bracing and side protection. A materials list can also be created at the push of a button and then printed out, together with an assembly sketch for the area to be enclosed in scaffolding plus the total weight.

LAYPLAN CAD

Integration into the LayPLAN system means that the basic planning can be done in an automated process using the proven LayPLAN CLASSIC. Project data can be quickly recorded using input masks, ensuring a time saving for every order. A visual collision check is possible with the aid of volume rendering. By using a convenient search function with preview image, scaffolding planners will find not only an extensive library of individual Layher parts, but also assemblies already prefabricated for even faster design work. In this way projects can be not only planned economically and at the same time adapted precisely to actual requirements. The LayPLAN CAD module is available in German, English, French and Spanish.

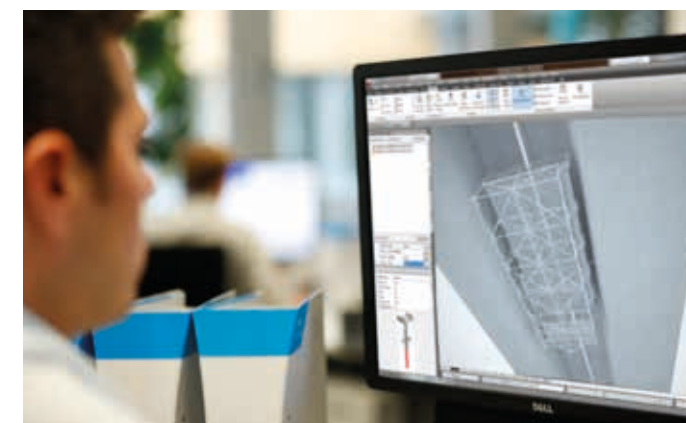

A STANDARD FOR EVERY APPLICATION.

Thanks to the pull-resistant and integrally cast spigot, two standards become one. The Allround Standard LW can be used in free-standing or suspended scaffolding. That increases economic efficiency while reducing incorrect application.



INTEGRATED SYSTEM

System-integrated for greater efficiency and for planning certainty. With Layher scaffolding systems, it is possible despite continuous further developments to combine new material with material from earlier generations.



INCREASED LOAD-BEARING CAPACITY

The increased load-bearing capacity of the U-Ledger LW means that for bird-cage scaffolding, it is possible depending on the load requirements to dispense with a chequerboard arrangement of the scaffolding decks. That means up to 50 % of the bridging ledgers previously needed can be dispensed with. As a result you achieve a considerable reduction in both weight and material price. For example, a chequerboard deck arrangement is then only necessary if, for example, load class 6 is to be achieved with a standard dimension of 2.57 x 2.57 m.

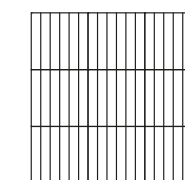

Variant A:
Decks unidirectional

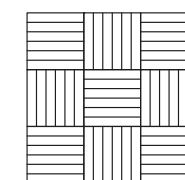

Variant B:
Decks in chequerboard layout

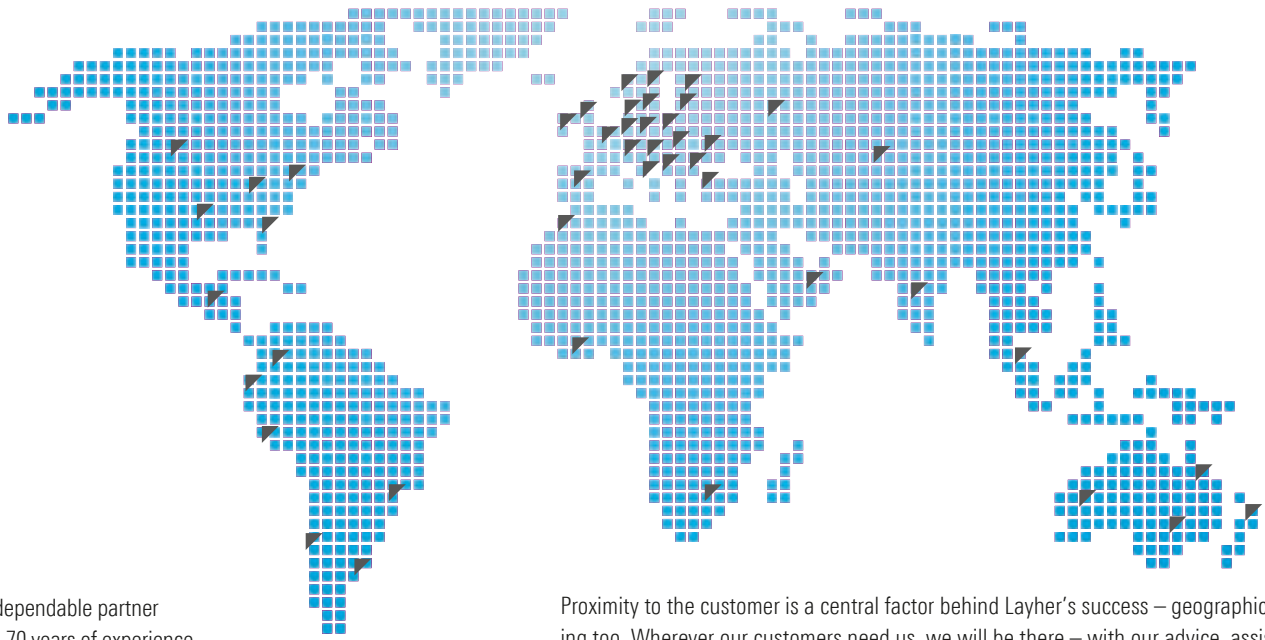

Layher is your dependable partner with more than 70 years of experience. "Made by Layher" always means "Made in Germany" too – and that goes for the entire product range. Superb quality – and all from one source.

Proximity to the customer is a central factor behind Layher's success – geographically speaking too. Wherever our customers need us, we will be there – with our advice, assistance and solutions.

-  **SpeedyScaf**
-  **Allround Scaffolding**
-  **System-free Accessories**
-  **Protective Systems**
-  **Shoring**
-  **Event Systems**
-  **Rolling Towers**
-  **Ladders**



Headquarters in Eibensbach



Plant 2 in Gueglingen

Layher 

More Possibilities. The Scaffolding System.

Wilhelm Layher GmbH & Co KG
Scaffolding Grandstands Ladders

Ochsenbacher Strasse 56
74363 Gueglingen-Eibensbach
Germany

Post Box 40
74361 Gueglingen-Eibensbach
Germany

Telephone +49 (0) 71 35 70-0
Telefax +49 (0) 71 35 70-2 65
E-mail export@layher.com
www.layher.com

